

STOVES™

Our Warranty

Should you need it

Inside the paperwork which has come with this appliance, there is a leaflet and card explaining the terms of our extended warranty and guarantee.

In order to apply for our five year guarantee, simply fill in the details on the card and post it off, this will register your appliance.

Should you wish to take out extended warranty, please fill in the details on the leaflet and post this off to:



Glen Dimplex Australia,
Unit 2, 205 Abbots Road
Dandenong South
Victoria 3175
Australia

If your appliance is covered by the warranty and guarantee, you will not be billed for work undertaken should your appliance be faulty, terms and conditions do apply, so please read through the literature carefully.

Please ensure that you have available your appliances model number and serial number, there is a space at the back of this book for recording that information.

IMPORTANT NOTICE

Please note the cooling fan fitted to this appliance is an integral part of its safety and functionality.

When the appliance is installed care must be taken that the cooling fans performance is not impeded by any objects coming into contact with it. (Installation pipes, leads etc)

Care must also be taken that there is sufficient air flow at the rear of the appliance for the cooling fan to run at its optimum efficiency. (Particularly Built In appliances) See clearance dimensions in the installation section of the booklet.

During use the Appliance must never be disconnected from the Mains supply as this will seriously affect the safety and performance of the appliance, particularly in relation to surface temperatures becoming hot and gas operated parts not working efficiently.

The cooling fan is designed to run on after the control knob has been switched off to keep the front of the appliance and the controls cool until the appliance has naturally cooled itself.

Contents

User's Section	1
Before using your cooker	1
About your cooker	2
Cooker safety	3-4
Using the programmer/clock	5-7
.....
Your Hob - Introduction
Switching on	8
Note for Ceramic/Halogen hobs	9
Safety	10
How your induction hob works	11
Choice of pans	12
switching on	12
Features (timer/Power boost/ warming zone)	13
Hints and Tips	14
Cooking guide	15-16
.....
Using Your Ovens
Using your Multifunction oven	17
Using you fan oven	18
Oven and grill functions	19
Using your grill	20
Using your multifunction oven	21
Fanned oven guide	22
Cooking guide	23
Roasting guide	24-25
Baking guide	26
Defrosting guide	27
.....
Your Slow Cook Oven - Introduction
Using your slow cook oven	28
Keeping food warm/how to use your slow cook oven	29
.....
Cleaning Your Appliance
Cleaning your hob	30
Cleaning your ovens	31-32
Before you call	33
Changing light bulbs	34
.....
Installation Instructions
Requirements and Regulations	35
Before you start	36
Clearances	37
Fitting accesories	38
Electrical conection	39
Technical Data	40-44

Before Using Your Cooker



Before using this appliance please make sure that you have removed all packaging and wrapping. Some of the furniture inside this appliance may have additional wrapping.



It is also advised that you turn the ovens and/or grill on for a short while, this will burn off any residues left from manufacturing. There may be a smell which accompanies this process - but this is nothing to worry about and is harmless.



We also recommend that you wash the oven shelves, the baking tray, the grill pan, and the grill pan trivet before their first use in hot soapy water, this will remove the protective oil coating.



Although every care has been taken to ensure this appliance has no burrs, or sharp edges, we recommend that you wear protective gloves when installing and moving this appliance. This will prevent any injury.



Our policy is one of constant development and improvement. Strict accuracy of illustrations and specifications cannot be guaranteed. Modification to design and material may be necessary subsequent to publication.



Please bear in mind that not all the sections inside this handbook are relevant to your appliance, but you should read carefully the sections which are relevant before installation and use. This will save you time.



Always use a registered installer for this appliance.



Environmental protection:

Stoves are committed to protecting the environment.



All packaging with this appliance is recyclable and environmentally friendly.

Please recycle whenever possible - contact your local authority for your nearest recycling centre.



This appliance is for use in a domestic kitchen only, it is not designed, or intended, for commercial use.

About Your Cooker

The illustrations below show the different cavity and hob layouts available within dual fuel ranges.

 = Programmable oven
(see timer section)

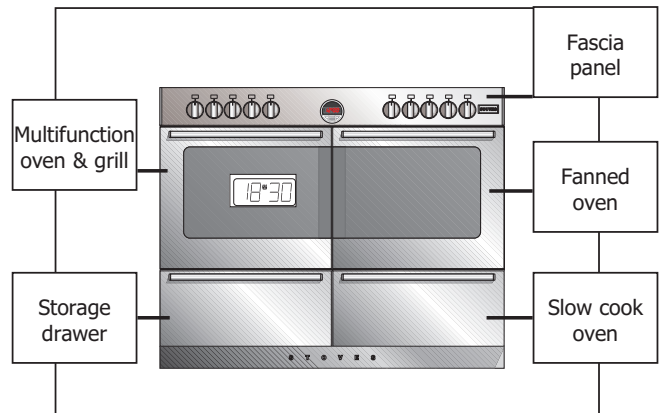
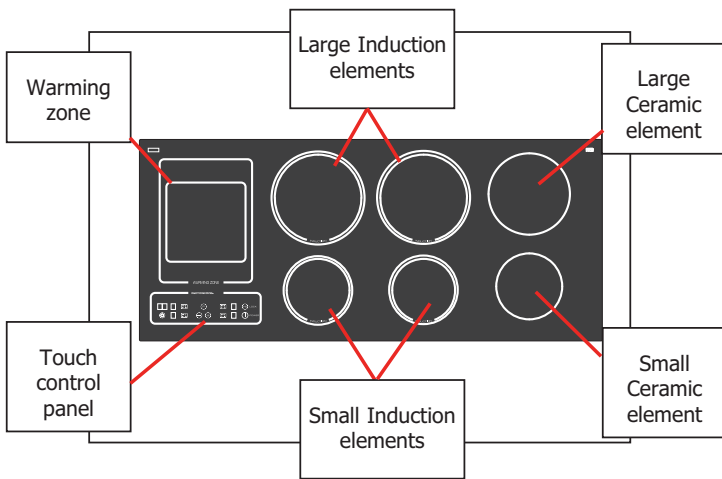

Hob & Cooker Safety

- ✓ Always ensure that pan bases are dry, and flat before using them on the hob.
- ✓ Always position pans over the centre of the element, and turn the handles to a safe position so they cannot be knocked or grabbed.
- ✓ Always use pans which are no smaller than 100mm (4"), or larger than 250mm (10").
- ✓ Always take care when removing food from the oven as the area around the cavity may be hot.
- ✓ Always use oven gloves when handling any utensils which have been in the oven as they will be hot.
- ✓ Always make sure that the oven shelves are resting in the correct position in between two runners. Do not place the oven shelves on top of the highest runner, this will lead to spillage and injury if the baking tray, or dish falls.
- ✗ Never use double pans, rimbased pans, old or misshapen pans, or any pan which is not stable on a flat surface.
- ✗ Never leave cooking fat, or oil, unattended.
- ✗ Never use commercial simmering aids, or heat diffusers, as they create excessive heat and can damage the surface of the hob.
- ✗ Never use the hob for any other purpose than cooking food.
- ✗ Plastic cooking utensils can melt if they come into contact with a warm hob. Never leave them close to, or on top of the hob.
- ✗ Never leave the element alight without a pan covering it. This causes a fire hazard.
- ✗ Do not place items of the door while it is open.
- ✗ Do not wrap foil around the oven shelves, or allow it to block the flue.
- ✗ Do not drape tea towels near the oven while it is on, this will cause a fire hazard.
- ✗ Do not pull heavy items, such as turkeys, or large joints of meat, out from the oven on the shelf, as they may overbalance and fall.
- ✗ Do not use this appliance to heat anything other than food items, and do not use it for heating the room.



WARNING: Parts of the appliance may become hot while in use, always make sure that children are supervised when they are near to the appliance.



Call for a service engineers visit if:

- You find over a period of time that the gas oven becomes hotter at a particular temperature - the thermostat may need replacing.
- The cooling fan fails to

Always use the Minute Minder (if fitted) if you are leaving the oven unattended, this reduces the risk of food burning.



Warning (ceramic glass): Never use the hob if the ceramic surface is cracked, broken or shattered. This creates a high risk of injury. Switch off the electric supply and call for a service engineer to come out.



Warning (ceramic glass): Do not stare at the halogen elements (if fitted). This may impair your vision!

Aluminium foil:

Do not leave foil on the hob top, it reflects heat back into the element which leads to damage.

Slow cooking time?

Check the base of your pan. Shiny pans can often reflect heat back into the element causing it to cycle on and off more.

Chip Pan Fires

What causes a chip pan fire?

- Chip pan fires start when oil or fat overheats and catches fire, or when oil or fat spills on to the cooker because the pan has been filled too high.
- They can also start when wet chips are put into hot oil, making it bubble up and over flow.

Preventing a chip pan fire

- Never fill the pan more than a third full with oil or fat.
- Never leave the pan alone with the heat on - even for a few seconds.
- Dry chips before putting them in the pan.
- Never put chips in the pan if the oil has started smoking. Turn off the heat and leave the oil to cool down, or else it could catch fire.

In the event of a chip pan fire





- If your chip pan does catch fire - don't panic, and don't move the pan. Serious burns are often caused by picking up the pan and running outside with it.
- If it is safe to do so, and you don't have to reach across the pan, turn off the heat.
- Never throw water, or use a fire extinguisher.
- If you can, drape a damp cloth or towel over the pan to smother the flames.
- Leave the pan to cool down for at least half an hour.
- If you can't control the fire yourself, close the door, get out and tell everybody else to get out.
- Call the fire brigade. Don't go back inside whatever the reason.

Using The Programmer/Clock

Through your programmer you will be able to set the time of day, set the minute minder, and use the semi and fully automatic cooking functions. The programmer is vital to the working of your appliance, and reading this section will make sure that you get the most out of your ovens.

The programmer buttons

There are three buttons on this type of timer. The table below shows you what their symbols look like, depending on the model type, and what they do.

Symbol	Symbol	What is it?
	-	Down / Minus Used to decrease cook / end time, remove minutes from the minute minder and adjust the time of day. Also for listening to and setting the alarm tone.
	+	Up / Plus Used to increase cook / end time, add minutes to the minute minder and adjust the time of day.
	FUNCTION 	Function button Used to select the functions available on this timer. Press once for: Minute Minder. Press twice for: Cook time Press three times for: End time. How to use these functions is explained later on in this section.

Setting the time of day

- Press the Plus and Minus buttons together for a few seconds, and release.
- The '●' in between the numbers on the LED Display will begin to flash.
- While the '●' is flashing it is possible to adjust the time using the Plus and Minus buttons.
- Once the time has been set, allow approximately 30 seconds before using any of the other timer functions. This ensures that the time will remain correct.

Setting an alarm tone

There are three tones to choose from.

- Press and release the minus button.
- Once the minus button is released, the tone is selected.

What your timer symbols mean.

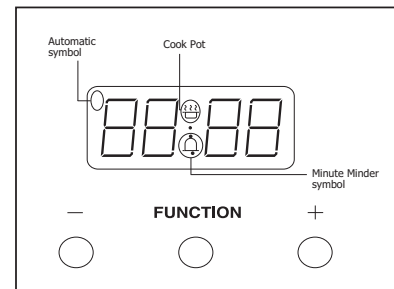

i This is a 24 hour clock. Before you do anything with your appliance - you must set the correct time of day.

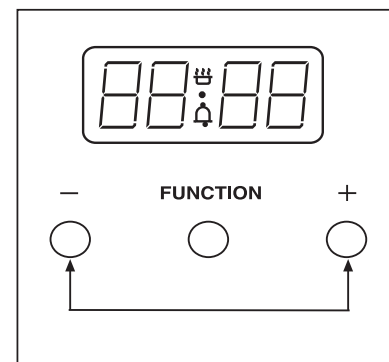

Using The Programmer/Clock

Setting the minute minder

- To set the Minute Minder, press the Function button once. The bell symbol will appear and start flashing. The flashing only lasts for 5 seconds so the time must be set within this time frame.
- Use the Plus and Minus button to set the length of time required. Once this has been done, the Minute Minder is set.
- When the desired length of time has counted down the alarm will sound. To cancel the tone, press any of the buttons.
- To cancel the Minute Minder at any time, press the Plus and Minus buttons together.

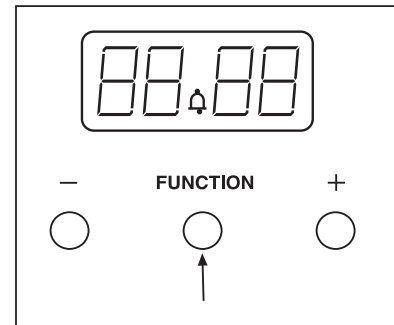

Semi - Automatic Cooking

The Duration method

Switch off after a set time period

- Press the Function button twice, which will skip past the Minute Minder.
- The display will flash the word 'dur', and the 'A' will flash on the left hand side of the display.
- Use the Plus and Minus buttons to set the length of time you want to cook for. This must be done within 5 seconds or the time of day will show again.
- Once this is done the oven will automatically switch off once the time has elapsed, and the alarm will sound. To switch off the alarm, press any button.
- To view any remaining time press the function button twice.

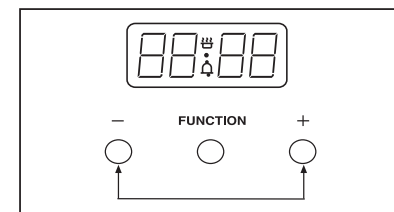
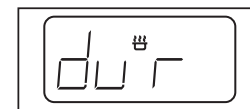
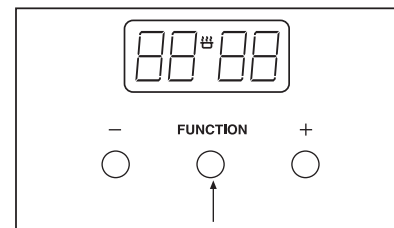

The End Time method

Switch off at a set end time

- Press the Function button three times, which will skip past the Minute Minder and the Duration programmer.
- The display will flash the word 'End' and the 'A' will flash on the left hand side of the display.
- Use the Plus and Minus buttons to select the time the oven is required to turn off.
- Once this is done the oven will turn itself off at the time you have selected. To switch off the alarm, press any button.

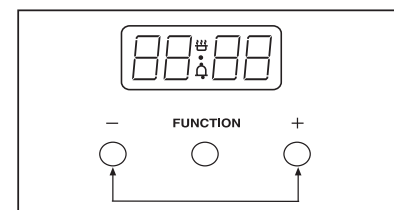
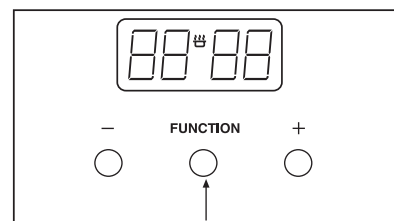

Setting the Programmer

Fully Automatic Cooking

Switch on and off automatically

This requires both the duration and the end time to be entered. The timer will work out the start time and begin cooking.

- Press the Function button twice, which will skip past the Minute Minder.
- The display will flash the word 'dur', and the 'A' will flash on the left hand side of the display.
- Use the Plus and Minus buttons to set the length of time you want to cook for. This must be done within 5 seconds or the time of day will show again.
- Press the Function button three times, which will skip past the Minute Minder and the Duration programmer.
- The display will flash the word 'End' and the 'A' will flash on the left hand side of the display.
- Use the Plus and Minus buttons to select the time the oven is required to turn off.
- Once this is done the oven will turn itself off at the time you have selected. To switch off the alarm, press any button.
- **Set the temperature of the oven and place the food inside.**
- The timer will calculate the appropriate start time.

When using the Programmer:

✓ Do:

- Familiarise yourself with the use of the programmer.
- Select foods which are as fresh and as cold as possible preferably straight from the refrigerator.
- Choose foods which are suitable for cooking from a cold start, as some dishes will be affected by being left uncooked, at room temperature.
- Make sure that meat, poultry and uncooked food are thoroughly thawed before placing them in the oven.
- Cover dishes with lids or foil.
- Try to keep the end time as close to your return as possible.

✗ Do not:

- Place warm food in the oven for delayed cooking foods must be thoroughly cooled before placing in the oven, the oven must also be cool before you start.
- Cook dishes containing left over cooked meat or poultry, or pastry dishes with wet fillings, they are not suitable!
- Over-fill dishes containing liquids.

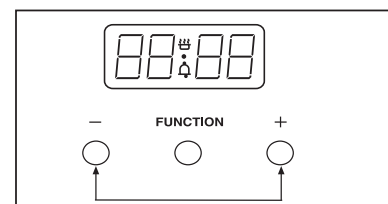
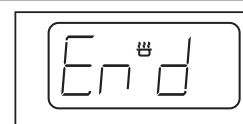
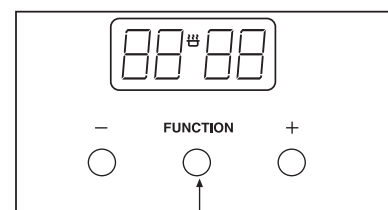
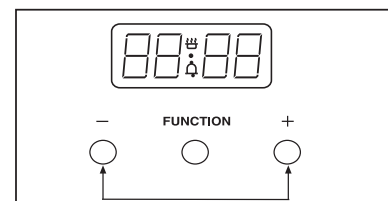
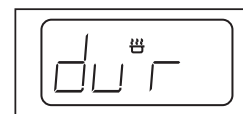
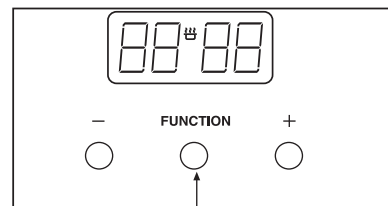

i The automatic cooking symbol will appear to show that the oven is no longer in manual mode but in automatic mode.

i Important: Once the oven has switched itself off please make sure you turn to oven controls to the 'off' position and set the oven to manual by pressing the Cook Time and Ready Time buttons together.

i Important: Remove food as soon as it is cooked.

Using Your Ceramic Hob

Introduction

Your hob may have halogen element (s) as well as the standard ceramic elements. In terms of care and use the procedure remains the same as with the other elements.

The hot hob light

The hot hob light will come on when one of the hotplates is switched on. It will remain on for a short time after the last element has been switched off to serve as a reminder that the hob top may still be warm to the touch.

Switching on - touch control

- Select the element you wish to use, place the pan on and touch the relevant control pad to the heat you wish to use.
- The temperature settings on the hob do not indicate any set temperature and cannot be used to judge one element against another.
- During cooking, the elements will cycle on and off, this is to prevent the hob from overheating.
- In addition for your safety, there may be a 'hot hob' light, this will indicate that the hob has been recently used and may still be hot to touch.
- To switch off, touch the selected control pad.

Energy Saving

- Position pans centrally over the elements.
- Only heat the amount of liquid you need.
- Once liquids have been brought to the boil, reduce the heat setting to a simmer.
- Consider using a pressure cooker if possible.
- Vegetables in small pieces will cook quicker.
- Use a pan which is a close match to your element size.
- Smaller elements are ideal for simmering and stewing in smaller pans, while the larger elements are ideal for frying and boiling.



Always make sure that children are supervised when they are near to the appliance when it is in use.



Before use:

Apply a thin coat of ceramic hob cleaner to the hob to help maintain and protect it. Supplies can be purchased from our Customer Parts Centre. The part number and contact number are towards the back of this guide.



Use flat based pans which are the correct size for your burners and suitable for your hob type.

We recommend the following sizes:

100mm or 4" min.

250mm or 10" max.

Smaller or larger pan sizes may lead to slower cooking times.



Try to avoid spillages of salty substances or sugary substances onto your hotplate spillage well, as this may cause staining and damage your hob.

Clean the hob top as regularly as possible, this will prevent any build up of grease which may be a fire hazard.

Using Your Ceramic Hob

Notes for Ceramic / Halogen hobs:

- **Warning:** Do not stare at the halogen hob element while it is in use - doing so may temporarily impair your vision.
- Do **not** use the ceramic glass surface of the hob as a work surface or chopping board, this will cause damage to the glass.
- Do not use commercial simmering aids as they cause excess heat which can damage your hob top and cause a hazard.
- Plastic utensils may melt onto the hob top if they come into contact with it while it is warm.
- Please be aware that the surface of this hob is smooth. If pans are knocked they will move on the hob top. Make sure pans are not overhanging the edge of the hob to prevent this wherever possible.
- Use pans which are large enough for the foods inside to avoid over flowing - this may cause damage to your hob.
- Pans with dull or dark coloured bases give the quickest results. All pans used on ceramic/halogen hobs should have thick, flat, smooth bases to ensure maximum contact with the element.
- Aluminium pans will give goods results, but please take care when using them. If they are skid across the hob top they tend to leave visible marks which can be difficult to remove.
- Foods in salted water, or with a high sugar or syrup content may cause damage if they are spilled onto the hob during cooking.
- Aluminium foil must **not** be placed onto the hob, it will reflect any heat back into the element - which can damage it.
- Pans with highly polished bases may also reflect heat back into the element causing the hotplate to cycle on and off rapidly, which slows down cooking.
- Do not leave the element on without it being covered by a pan as this can cause over heating.

Using Your Induction Hob

If you are fitted with a pacemaker or an active implant

The functions of the hob comply with the applicable standards on electromagnetic interference

Your induction cooking hob thus complies fully with the statutory requirements (Directive 89/336/EEC). It is designed to not interfere with the functioning of other electrical equipment as long as these also comply with the same regulations.

Your induction hob generates magnetic fields in its immediate vicinity.

So that there is no interference between your cooking hob and a pacemaker, the pacemaker must be designed in compliance with the appropriate regulations

In this respect we can only guarantee the compliance of our own product. You can ask the manufacturer or your doctor about the compliance or any incompatibilities of

Using Your Induction Hob

How your Induction hob works

Induction currents instantly heat the pan, which then passes its heat on to the food it contains.

With an induction hob, the heat necessary for cooking food is produced directly inside the pan; the ceramic glass hardly heats up at all, as it only receives heat from the pan placed on it - see diagram.

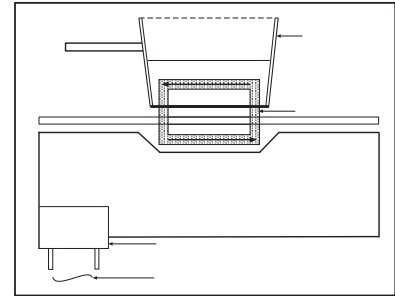

When compared with conventional cooking hobs, your induction hob is;

- **More economical** - when a pan is lifted off, the zone stops heating immediately.
- **Quicker** - 3000W of power is immediately available at the heating zone.
- **More precise** - the hob reacts immediately to your instructions.
- **Safer** - the temperature of the glass top remains relatively low.

Choice of pans

- **Note:** A pan with a base not absolutely flat may still be suitable, as long as it is not too distorted.
- Choose a pan bearing the **CLASS INDUCTION** logo on its base or packaging to be sure that it is perfectly suitable for use on your hob under normal conditions of use.
- You can also find a range of pans suitable for induction cooking by looking in quality kitchen shops. Look for the wording and symbol "suitable for induction".
- You probably already have some suitable pans:
- **Pans in enamelled steel, with or without non-stick coating**
For example; cooking pot, chip pan, frying pan, meat grill pan, etc.
- **Cast iron pans**
To avoid the risk of scratching the glass top of your hob, use pans with an enamelled base, or avoid sliding the pan across the glass surface.
- **Stainless steel pans suitable for induction**
Most stainless steel pans are suitable for induction cooking. Some stainless steel pans have copper bases which are usually not suitable.
- **Aluminium pans with a special base**
Choose pans with a thick base, as this ensures more even cooking (the heat is more evenly distributed).



Always make sure that children are supervised when they are near to the appliance when it is in use.



Before use:

Apply a thin coat of ceramic hob cleaner to the hob to help maintain and protect it. Supplies can be purchased from our Customer Parts Centre. The part number and contact number are towards the back of this guide.



Use flat based pans which are the correct size for your burners and suitable for your hob type. We recommend the following sizes:
100mm or 4" min.
280mm or 11" max.
Smaller or larger pan sizes may lead to slower cooking times.



Try to avoid spillages of salty substances or sugary substances onto your hotplate spillage well, as this may cause staining and damage your hob. Clean the hob top as regularly as possible, this will prevent any build up of grease which may be a fire hazard.

Using Your Induction Hob

Incompatible pans

Glass, ceramic or earthenware pans, aluminium pans (unless they have a special base), copper pans, some non-magnetic steel pans.

The pan test

Because of its leading-edge technology, your induction hob is able to "recognise" most pans.

Place your pan on a heating zone on power setting **4**;

- If the indicator stays fixed, your pan is compatible.
- If the indicator flashes, the pan cannot be used for induction cooking.

Switching on

Look for the controls which correspond to the zone where you have put your pan.

- Press the **ⓘ** key.
The power indicator shows **0**, next to all of the heating zone selectors and the hob is switched on.
- Use the heating zone selectors to choose which zone you wish to use. Ensure that your pans are in place first.
- Adjust the heating power you want using the **+** and **-** key.

After you have pressed the on/off control **ⓘ** key, if you do not touch any sensor within 10 seconds, the instruction will be automatically cancelled.

- Adjust the power during cooking.
You can adjust the heating power from **1** to **9** at any time during cooking using the **+** and **-** keys.

Turning a heating zone off

There are two ways to switch off the Induction hob:

- Touch the **'-'** sensor until the display shows **'0'**
- Touch the **'+' and '-'** sensors together.

Audio Warning

An audio signal sounds when your appliance detects a problem on the control panel, such as:

- An object (pan, cover, etc) placed on the control panel for more than ten seconds.
- A spill on the control panel
- Prolonged pressure on the control panel.

The hob will also switch itself off.

To reset, simply touch the power on sensor.

i A small object - such as a fork, a spoon or even a ring - placed on a hob cooking zone on its own is not detected as a pan. The display flashes and no heating power is supplied. The security system acts in the same way when it detects a pan which is not suitable for use on an induction hob.

i **Note:** Next to the power indicator is a **'.'** this will flash when a zone has **not** been selected. When the **'.'** is static a zone has been selected and the power levels can be adjusted. You must make sure you have selected a zone before you start, otherwise you cannot make any adjustments.

i **Note:** The hob is equipped with 2 or 4 residual heat indicators. The display shows **'H'** if the temperature of that heating zone exceeds 60°C. This prevents the risk of burning.

Using Your Induction Hob

The Zone Indicator (Timer)

- On the timer there are four lights at the corners, these correspond to your heating zones.
- As with the power indicators, these will flash when not selected and remain static when selected.

Programming a cooking duration

- Select the timer key to access the programming function. The corresponding indicator lights flash.
- Press the '+' key to display the required cooking duration (max 99 mins)
- Press the timer key to confirm the programming operation.

Multiple programming

- It is possible to programme more than one heating zone at a time.
- Simply repeat the above steps on whichever zones you wish to use.

Note: The indicator light will remain lit once the duration has been confirmed.

- To see how long a zone has, select the zone you wish to look at and touch the sensor. The indicator light will remain lit and the time remaining will show.
- An audio signal will sound once the various times have counted down and the zone will switch itself **off**.

The Power Booster

- To use the power booster for rapid heating, touch the Booster sensor 'P', the power indicator will display a P.
- The booster function stops after 4 minutes automatically. While the booster is on the heating zones at the front of the hob will only reach 600W, this is to prevent over heating.

The warming zone (if applicable)

- To operate the warming zone touch the warming zone symbol.
- The display above will show '1' to indicate that the zone is active.
- Place your pan on top.
- To switch off the warming zone, simply touch the warming zone symbol again.
- The display will show 'H' - alerting you that it may be hot to touch with any residual heat.
- Alternatively, the zone can be turned off when the power symbol is touched to turn off the hob.



Note:

The timer starts counting down immediately. An audio signal sounds at the end of cooking time, and the heating zone switches off. Press the off key to switch off the appliance.



Note:

Once a further zone is programmed and confirmed, that will remain lit and the indicator light for the zone programmed first will begin to flash. **This is not an error**, continue with cooking, or programming.



The warming zone:

Ideal for keeping food warm on an extremely low heat to prevent burning.

Using Your Induction Hob

Cooking with your induction hob

- Do not leave an empty pan on a heating zone.
- Pans should be placed in the centre of the heating zone.
- Never heat up a sealed tin of food, as it may explode.
- **After use, please ensure that you switch the appliance off. Do not rely on the pan detector.**
- When you use a pan with a non-stick coating (eg; Teflon) with little or no fat, heat the pan first for a moment on setting **6** or **7**.
- We recommend that you do not put metal cooking utensils, cutlery, knives or other metal objects on the hob, as they could become hot if they are near a cooking area which is in use.
- It is perfectly possible to use a pan with a smaller diameter than that of the ring marked on the vitro-ceramic glass (note that we recommend a minimum 5" pan base diameter); there will be no loss of energy as is the case with conventional cookers (electricity and gas).
- Nothing should ever be left lying on the hob.
- Do not use the hotplate surface for storage.
- Lift pans onto and off the hob, rather than sliding them across the surface, to avoid marks and scratches.
- As soon as the water boils, turn the cooking zones down to a lower setting; this will help prevent pans boiling over.
- Do not use the vitro-ceramic glass surface as a work surface or chopping board, as it will damage it, and if any plastic utensils come into contact with a warm hob, they may melt onto it.
- As pans are on a smooth surface, they will move easily if knocked accidentally; turning pan handles so they are not overhanging the edge of the hob, will help prevent this happening and keep them out of the reach of children.
- Be careful when cooking foods in salted water, or foods containing large amounts of sugar or syrup if they are spilt onto hot areas of the hob they may damage the glass.
- Wipe any spillage as soon as possible.
- Use pans which are large enough to avoid overflows onto the ceramic glass hob surface.

Using Your Induction Hob

Cooking guide

For best cooking results, follow the examples in the guide below, bearing in mind that settings **8** and **9** are maximum positions and should only be used for deep frying and bringing up to the boil quickly.

Preparation	Very fast frying		Fast	Medium		Slow	Simmering, re-heating		Keeping warm
	9	8	7	6	5	4	3	2	1
Soup									
Thin soup					✓				
Thick soup						✓			
Fish									
Court-Bouillon			✓						
Deep fried					✓				
Sauces									
Thick, flour based							✓		
Buttery, containing eggs								✓	
Vegetables									
Spinach				✓	✓				
Pulses							✓		
Boiled potatoes						✓			
Carrots				✓	✓				
Saute potatoes				✓	✓				
Frozen vegetables						✓			
Meat									
Thin cuts of meat	✓								
Fried steak		✓							
Other types of cooking									
Deep frying: frozen chips	✓								
Deep frying: fresh chips	✓								
Pressure cooking	✓				✓				
Stewed fruit						✓			
Pancakes	✓	✓							
Custard								✓	
To melt chocolate									✓
Jam						✓			
Milk									
Fried eggs				✓					
Pasta	✓								
Re-heating baby food							✓		
Rice pudding								✓	
Keeping food warm									✓
Stews								✓	

Using Your Induction Hob

Cooking tips

- Green vegetables (spinach, broccoli, sorrel, etc) or vegetables rich in sulphur compounds (cabbage, onions, etc) should be cooked without a lid in plenty of boiling water; they will cook more quickly, and will keep their green colour (some vegetables only), vitamin and minerals content.
- Pasta, rice, cereals, etc absorb water during cooking and increase in volume; cook them in plenty of boiling salted water in order to dilute the starch they contain.
- Make sure you use a sufficiently large pan to avoid boiling over; the temperature setting may need to be reduced to maintain a simmer.
- Mushrooms should be poached in a small quantity of boiling water, with salt, butter and lemon juice.
- When liquids boil, reduce the control setting to maintain a simmer.
- Vegetables will cook quicker if chopped in smaller pieces.

Aluminium foil

- When cooking, never use kitchen foil and never put items wrapped in kitchen foil straight onto the hob.
- The aluminium kitchen foil may melt and do irreparable damage to your appliance.

Safety

- Regularly check that there is nothing (cloth, paper, etc) which might block the air inlet underneath your hob (see section "Installation Instructions").

Hob Lock

- For your safety this hob has fitted with a hob lock.
- To activate touch the lock sensor.
- To unlock, simply press the sensor again.

Using Your Multifunction Oven

The multifunction oven may be controlled by the programmer (see The Programmer/Clock for details).

The programmer, if fitted must be set to manual before it can be used, or programmed.



Important: Never place food, or dishes on the base of the main oven, the element is here and it will cause over heating.

Switching on the multifunction oven

- Use the function control knob to select the function you wish to use - see the functions table for details.

Note: You can change function during cooking if you wish, as long as the oven is in manual mode.

- Turn the temperature control knob to the temperature you wish to use.
- The thermostat indicator will come on to show that the oven is heating, and once the temperature is achieved, it will go out.
- To switch off the oven, simply turn the control knob back to the '●' position.
- The cooling fan may come on during use, and may continue to run for some time afterwards.

Using Your Fanned Oven

Switching on the fanned oven











- Use the main oven control to turn your oven on, and select your temperature.
- The thermostat indicator will come on to show that the oven is heating, and once the temperature is achieved, it will go out.
- To switch off the main oven, simply turn the control knob back to the '●' position.
- The cooling fan will come on during use, and may continue to run for some time afterwards.



Important: Never place food, or dishes on the base of the main oven, the element is here and it will cause over heating.

Oven & Grill Functions

The chart below details all of the functions which are available. Your oven may not have all of the functions shown here.

Main Oven Function		Recommended Uses
	Base Heat Only	Used to finish off the bases of food following cooking using the conventional or fanned modes. The base heat can be used to provide additional browning for pizzas, pies and quiche. Use this function towards the end of cooking.
	Top Heat Only	The heat is ideal from browning off the tops of food as it is not as fierce as the grill following conventional or fanned cooking. Provides additional browning for dishes like Lasagna or Cauliflower cheese. Use this function towards the end of cooking.
	Conventional Oven	This function is ideal for traditional roasting. The meat is placed in the middle of the oven, roast potatoes towards the top.
	Intensive Bake	Suitable for food with a high moisture content, such as quiche, bread and cheesecake. It also eliminates the need for baking pastry blind.
	Fanned Grill	The fan allows the heat to circulate around the food. Ideal for thinner foods such as bacon, fish and gammon steaks. Foods do not require turning. Use with the oven door closed.
	Fanned Oven	The even temperature in the oven makes this function suitable for batch baking, or batch cooking foods.
	Defrost	To defrost foods, such as cream cakes/gateaux, use with the oven door closed. For cooling dishes prior to refrigeration, leave the door open.
	Dual Grill	This function cooks food from the top and is ideal for a range of food from toast to steaks. As the whole grill is working, you can cook larger quantities of food.
	Single Grill	For smaller quantities of food, but is still ideal for anything from toast to steaks.
	Base Heat with Fan	Used to cook open pies (such as mince pies) the base element ensures that the base is cooked while the fan allows the air to circulate around the filling - without being too intensive.
	Lights only	Use when the oven is switched off and cold to aid cleaning the oven cavity.

Using the Grill

Detachable grill pan handle

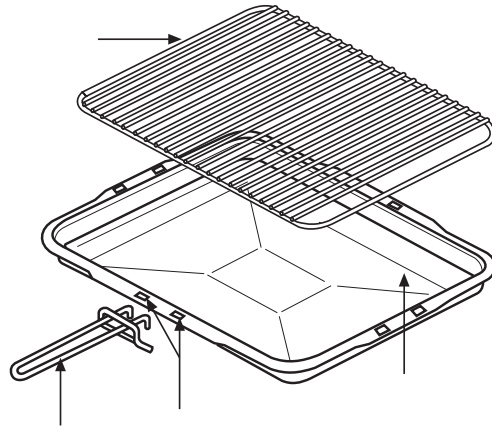

Place the handle over the edge of the grill pan, at the narrow side edges. Slide the handle to the centre, and locate between the handle position

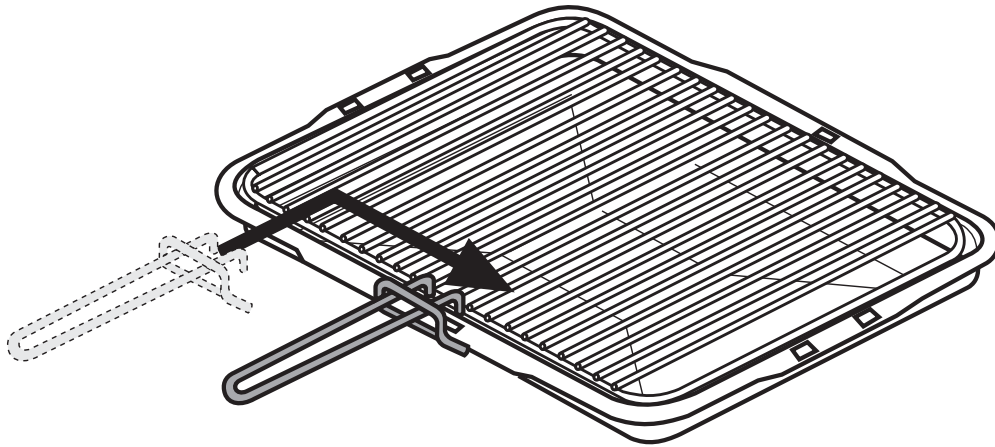

The handle should be removed from the pan during grilling, to prevent overheating. The handle is designed for removing / inserting the grill pan under the grill when grilling.

If cleaning the grill pan when it is hot, use oven gloves to move it. *Do not* use the handle to pour hot fats from the grill pan.

Food for grilling should be positioned centrally on the trivet.

Using Your Multifunction Oven Grill

Before you start grilling. . . .

Before you use the grill, make sure you have placed the grill shelf in the position you need as once the grill is on you may injure yourself if you try to move the shelf.

- This grill function can be used with the door open, or closed.
- Turn the selector control knob to the grill setting.
- Turn the grill control knob to either the dual or single grill setting. Then select the heat setting.
- To switch off, return the control knobs to the 'off' position.
- The cooling fan will come on during use, and may continue to run for some time afterwards.
- To adjust your results, you can turn the grid over, or remove it altogether.

If your grill is a dual grill:

- The dual grill uses all of the top element and is ideal for grilling large quantities of food.
- The single grill uses part of the element only, and is better suited to grill smaller amounts of food.

The grill neon

When grilling with the door closed, the neon will cycle on and off as the temperature is maintained inside the cavity. If the door is open, it will not cycle on and off.

i **Warning:** Accessible parts may become hot when the grill is in use. Children should be kept away.

i Types of grill

Fixed rate grill: has a full 'on' setting and 'off'.

Variable rate grill: has adjustable heat settings 1 (low) to 8 (high) or 5 (high) - depending on the model.

Single grill: has one grill element.

Dual grill: has two grill elements which can be used together, or as a

i For best results: Pre-heat the grill for about 3 minutes.

Fanned Oven Guide

- Some adjustment will have to be made to conventional cooking temperatures.
- The table below shows conventional cooking temperatures, fanned temperatures and gas marks.
For optimum results using the fanned oven setting, conventional temperatures need to be converted to the fanned oven temperatures.
- For example and item which would cook at 180°C will now cook at the fanned oven temperature of 160°C.
- This is a high efficiency oven, you may notice an emission of steam when the door is opened.
- When cooking chilled or frozen foods, use the recommended cooking times and temperature on the packaging. **Always** make sure the food is piping hot throughout before serving.
- There are no zones of heat, and no flavour transfer when using a fanned oven - allowing you to cook a greater variety of foods together.
- If you are cooking on more than one shelf, you may need to slightly increase the cooking time.
- Always make sure that there is enough space between dishes, to allow food to rise, and to air to circulate.

Conventional temp (°C)	'A' Efficiency oven (°C)	Gas mark
100	100	1/4
110	110	1/4
130	120	1/2
140	130	1
150	140	2
160	150	3
180 - 190	160	4 - 5
200	170	6
220	180	7
230	190	8
250	200	9

Cooking Guide

Pre-heating

To get the best results from your oven, we recommend pre-heating for around 5 to 15 minutes before placing your dishes in. This is especially important for items which are chilled, frozen, batter based, yeast based or whisked sponges.



If you are using a fanned function, you should still pre-heat but for a shorter time.

The items in the cooking guide below are based on a pre-heated oven, but can be adjusted to take into account personal taste.

Oven and bakeware

Always use high quality trays and tins for cooking. Poor quality tins and trays can warp in the oven producing uneven results.

Never use dishes which are cracked, damaged or not oven proof as heating may lead to shattering inside the oven.

Food Type	Temp. Setting °C			Time Approx.	Shelf Position
	Conv 	Fanned 	Intensive 		
Cakes					
Small cakes	190	175	-	15 - 25	7 & 12
Victoria sandwich	180	160	-	20 - 30	7
Semi rich fruit cake	150	125	-	2 ^{1/2} - 3hrs	5
Christmas cake	150	125	-	2 ^{1/2} - 3hrs	3
Puddings					
Bread & butter pudding	170	150	-	45 - 1hr	9
Fruit crumble	200	175	-	40 - 1hr	9
Miscellaneous					
Yorkshire pudding: large	220	200	200	40 - 45	11
small	220	200	200	15 - 20	12
Shortcrust pastry	200	180	180	depends on filling	top - middle

Roasting Guide

- Roasting times depend on the weight, shape and texture of the meat and personal preference. In order to calculate the roasting time, weigh the meat or poultry, **including the stuffing**, and follow the times given below.

Meat joints (including chicken) should be roasted at 180 - 200°C Conventional / 160 - 180°C Fanned for 20 - 30 mins per 450g/1lb, plus 20 minutes on shelf position 2.

- Frozen meat must be **thoroughly** thawed before cooking. For large joints, it is advisable to thaw overnight.
- Frozen poultry must be **thoroughly** thawed before cooking. The time required depends on the size of the bird - eg: a large turkey may take up to 48 hours to thaw.
- When cooking stuffed meat or poultry, calculate the cooking time from the **total** weight of the meat **plus** the stuffing.
- Cooking joints in foil, covered roasters, lidded casseroles, or roasting bags will help to reduce meat shrinkage, give a more moist result and may reduce fat splashing. However, a slightly longer cooking times will be required, **add 5 - 10 minutes** per 450g (1lb) to the calculated cooking time. When using roasting bags do not exceed the temperatures recommended by the manufacturer, and do not allow the roasting bag to touch the sides or top of the oven.
- Use of a trivet with the roasting tin will reduce fat splashing during open roasting, and will help to keep the oven interior clean.
- The use of a roasting tin larger than that supplied is not advised, as this may impair performance and lead to extended cooking times.

Roasting Guide

Roast turkey

- Roasting turkey perfectly involves cooking two different types of meat - the delicate light breast meat, which must not be allowed to dry out, and the darker leg meat, which takes longer to cook.
- The turkey must be roasted long enough for the legs to cook, so frequent basting is necessary. The breast meat can be covered once browned.
- Turkey should be roasted at 180 - 190°C Conventional/ 160°C Fanned for 20 mins per 1lb, plus 20 minutes.
- The turkey can be open roasted, breast side down, for half of the cook time, and then turned over for the remainder of the cooking time.
- If the turkey is stuffed, **add** 5 minutes per 1lb to the cooking time.
- If roasting turkey covered with foil, **add** 5 minutes per 1lb to the cooking time.
- To test if the turkey is cooked, push a fine skewer into the thickest part of the thigh. If the juices run clear, the turkey is cooked. If the juices are still pink, the turkey will need longer cooking. Always make sure that the turkey is cooked properly before serving.

Turkey Roasting times.

Most Turkeys are measured by the kilogram. Timing should be calculated in either of these ways:

40 minutes per 1kg plus 10 minutes per 1/4 kg.

or

20 minutes per 1lb, plus 20 minutes.

The maximum size Turkey for this appliance is: 20lbs approximately 9kgs.

Please do not attempt to roast a Turkey larger than this, as the results cannot be guaranteed.

General Baking Guide

Trouble-shooting - Fruit Cakes

PROBLEM	POSSIBLE CAUSE
Fruit sinking to the bottom	Low oven temperature which may cause the cake to take longer to set, allowing the fruit to sink. Or, too much liquid, or raising agent. The fruit may not have been properly washed and dried.
Cake sinking / dipping in the centre	Too much raising agent in the mixture. Too hot, or too cool an oven. Or, not enough liquid or insufficient creaming.
Surface cracks	Too small a tin, or too much mixture in the tin. Too much raising agent in the mix, plus not enough liquid or insufficient creaming. The oven may be too hot.
Hard outer crust with a damp patch inside	Oven too hot, therefore the cake baked too quickly. Too much sugar, or insufficient liquid.
Burnt outside	Oven temperature too high. Oven too small for the size of cake. Insufficient protection around the tin. Cake baked on too high a shelf.
Texture with pronounced holes.	Too much raising agent. Flour unevenly mixed.
Texture too close and cake insufficiently risen.	Not enough raising agent. Not enough liquid. Too cool an oven. Insufficient creaming.
Cake crumbles when cut	Not enough liquid. Baked for too long. Not enough sugar. Too much baking agent.
Too dry	Over baking. Insufficient egg or liquid. Too much raising agent.

Trouble-shooting - Sponge Cakes

Domed top	Insufficient creaming of mixture. Cake baked on too high a shelf position, or at too high a temperature. Paper liners can cause the outer edge not to rise and the centre to peak.
Hollowed / sunken top	Too much raising agent. Oven temperature too low, or incorrect shelf position. Cake removed from oven before it's cooked. Use of soft tub margarine.
Very pale, but cooked	Oven temperature too low. Baked too low in the oven
Overflowing tin	Tin too small for the amount of mixture

'Cooling & Defrosting' Function

- To **cool** foods quickly straight after cooking, but before refrigerating or freezing, turn the oven control to the defrost position, and **open** the door.
- To **defrost** frozen foods, turn the oven control to the defrost position, place the food in the centre of the oven and **close** the door.

Defrosting times

- Small or thin pieces of frozen fish or meat - eg; fish fillets, prawns, and mince will take approximately 1 - 2 hours. Placing the food in a single layer will reduce the thawing time.
- A medium sized casserole or stew will take around 3 - 4 hours.
- A 1¹/₂kg / 3lb oven ready chicken will take around 5 hours, remove the giblets as soon as possible.
- Always check foods are thoroughly defrosted before cooking.

Be safe

- Do not defrost stuffed poultry using this method.
- Do not defrost larger joints of meat and poultry over 2kg / 4lb using this method.
- Never place uncooked food for defrosting next to cooked food which is to be cooled, as this can lead to cross contamination.
- Defrosting meat, poultry and fish speeded up using this method, but make sure they are completely thawed before cooking thoroughly.
- Place meat and poultry on a trivet in a meat tin, to catch the juices from the defrosting process.

Using Your Slow Cook Oven (if fitted)

Introduction

One of your oven compartments is an electric oven which provides a gentle heat suitable for slow cooking or keeping food warm. The slow cook element is positioned in the base of the lower compartment - always make sure that the cooking pot is placed centrally on the base of this compartment.

- Do not use the compartment to store food or canned items.

Cooking times

The cooking time varies according to the type of food being cooked, and experience will show how long foods should be cooked for, according to personal taste and preference.

In general foods should be cooked for at least 5 hours, and may be left up to 8 - 10 hours without spoiling if covered. Foods cooked using the slow cook oven will take about three times longer than they would in a conventional oven.

Utensils

Any oven proof utensils may be used for slow cooking - provided they have a close fitted lid.

To rectify a badly fitting lid a piece of cooking foil may be placed over the dish, under the lid.

The most useful utensils for slow cooking are the flame proof type which can be used over direct heat and for oven cooking, and are sufficiently attractive to use as serving dishes.

Benefits of Slow Cooking

Slow cooking has always been the best way to prepare hot meals with the minimum of preparation and maximum time away from the kitchen.

The advantages of slow cooking are as follows:

- Food can be left to cook unattended for several hours and will keep hot for several hours if left covered.
- Inexpensive cuts of meat become deliciously tender when slow cooked. There is also a reduction in meat shrinkage.
- Dishes such as soups, vegetables, puddings savoury dishes and preserves are also suitable for slow cooking.
- There is no topping up of steamers, steam filled kitchens or constant checking to do.

Using Your Slow Cook Oven (if fitted)

Keeping food warm

Turn the oven control knob to the on position, and place the food in the oven. If food is to be kept moist then it is important to cover the dish or plate to prevent food from drying out. This can be done using aluminium foil if the dish does not have a lid.

- **Do not** use cling film to cover food.
- Some foods are best left uncovered if you wish to keep the food dry and crisp.
- Do not add gravy to plated meals until serving.
- Carved meat should be placed on one plate and covered, adding just one tablespoon of gravy to keep it moist.
- When keeping plated meals warm it is recommended that the food is placed on hot rather than cold plates.

Slow Cooking

Turn on the slow cook oven and place the prepared cooking pot centrally on the base of the oven. Follow the guide lines for the best results.

- The maximum capacity of ovenproof dishes should be no more than 2.5 litres (4.5 pints). Please note: The more you fill the dish/pot the longer it will take to cook.
- All meat and poultry recipes need a minimum of 5 hours to cook.
- Make sure all frozen ingredients are well thawed out.
- Cut root vegetables into smaller pieces as they take longer than meat to cook. If possible they should be sauteed for 2 - 3 minutes before slow cooking.
- Ensure that root vegetables are always at the bottom of the pan immersed in the cooking liquid.
- A meat thermometer should be used when cooking pork joints and poultry. The internal temperature of the food should reach 88°C,
- Stuffed meat or stuffed poultry should not be slow cooked. Cook any stuffing separately.
- Cover casseroles with a lid, or foil to prevent loss of moisture.
- Adjust seasoning and thickening at the end of cooking time.
- Opening the door during cooking, leads to heat loss, and will lead to increased cooking times.

Cleaning Your Electric Hob

Ceramic glass hobs (if fitted)

- The ceramic hotplates, and hob top can be cleaned using a clean, damp cloth or kitchen paper. Please ensure that the elements are cooled fully to avoid steam burns.
- You can use a specialist ceramic cleaner to restore the surface, but use sparingly to avoid coating the hob top too thickly, too much cream cleaner will lead to discolouration. Use a dry, clean cloth to polish the surface.
- For stubborn marks, a little cream cleaner and a specialist hob scraper can be used.
- **Do not** use steam cleaners.
- Regular cleaning will prevent any salts or minerals from accumulating on your hob and discolouring the glass.

Solid plate hobs (if fitted)

- Prime and Season - this helps maintain the finish of the elements.
- Use a damp, clean cloth to wipe the solid plate, making sure that you follow the circular grooves and avoid damaging the 'red spot(s)'. Make sure that you allow the hotplate to dry before use by switching on the elements at a low heat.
- You can restore the hotplates by using a solid plate cleaner.

Plastic & Painted parts

- Only use a clean cloth wrung out in hot soapy water.

Vitreous enamel surfaces (enamel hobs only)

- Use a mild cream cleaner on a clean cloth.

Stainless steel & Aluminium surfaces

- Only use a clean cloth wrung out in hot, soapy water.
- Stubborn marks can be removed by using a specialist cleaner, we also recommend that you clean the whole area, to maintain a uniform finish.
- Some foods are corrosive, eg: vinegar, fruit juices and especially salt, these can damage and leave marks on the surface. Wipe any spillage of these substances as safely, and as quickly as possible.
- **Do not** use steam cleaners



Always allow your appliance to cool down, and switch off the electricity before you clean any part of it.



Take care when cleaning over symbols on fascia panels, excessive cleaning can lead to the symbols fading.



Keep a separate cloth aside for cleaning your glass hob - this will prevent greases being transferred which can cause discolouration of the glass surface.

Solid Plate Hobs Only

To prime: Switch on each element in turn for a short while (with no pan on it) at a medium - high setting. This will harden and burn off the coating.

To season: Heat the element for 30 seconds at a medium setting then switch off. Use a minimum amount of unsalted vegetable oil on a dry cloth or paper towel, and apply a thin coat of oil to the element surface.

Wipe off the excess and heat



Baby oil can be used to restore stainless steel finishes - but only use a few drops. Don't use cooking oils as they can contain salts which will damage the metal.



Don't use:
Abrasive powder cleaners, wire wool, soap filled wire pads, detergents, bleaches, bath stain remover or chemical oven cleaners.

Cleaning your Cavities

Cleaning the oven cavities

- Some foods can cause fat to spit, especially if you have open roasted, this leaves the inside of the cavity greasy.
- It is important to clean the oven cavity as a build up of fat can damage the appliance and may invalidate your guarantee.

Chrome plated parts.

- Use a moist soap filled pad, or place in a dishwasher.
- Shelf runners can be removed to enable you to clean then thoroughly. Make sure they are cool to touch and then grasp the runners and slide out of their hanging holes.

Pristine enamel surfaces

- The enamel can be cleaned by wiping the surfaces with a clean cloth which has been wrung out in hot, soapy water.
- If larger splashes of fat do not readily disappear, you can use a mild cream cleaner to remove them. More stubborn marks can be removed using a soap filled pad.
- Rinse well, and allow to dry before use.

Vitreous enamel surfaces

- The enamel can be cleaned by wiping the surfaces with a clean cloth which has been wrung out in hot, soapy water.
- Stubborn marks can be cleaned using a moistened soap filled pad, or a mild cream cleaner.
- Rinse well, and allow to dry before use.



Always allow your appliance to cool down, and switch off the electricity before you clean any part of it.

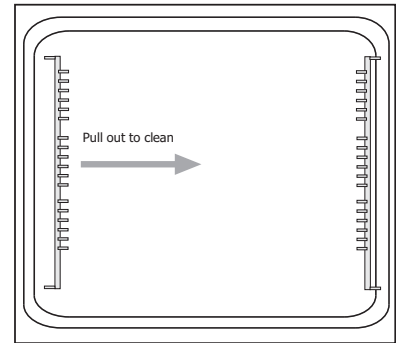

Don't use:
Caustic or abrasive cleaners, bleaches, coarse wire wool or hard implements, these will damage your appliance.



Using a trivet while roasting meat may help to reduce fat splashes.

Cleaning your Appliance

Painted & Plastic parts

- Only use a clean cloth wrung out in hot soapy water.
- **Do not** use abrasive cleaners, such as "Cif", wire or nylon cleaning pads on these parts.

Stainless steel & Aluminium surfaces

- Only use a clean cloth wrung out in hot soapy water, and dry with a soft cloth.
- Stubborn marks can be removed using a stainless steel cleaner. Supplies can be purchased from the Customer Care Centre.
- Sharp objects can mark the surface of stainless steel, but will become less noticeable with time.
- Wipe any spillage immediately, taking care to avoid burning your hands.
- Some foods are corrosive eg; vinegar, fruit juices and especially salt they can mark or damage the metal if they are left on the surface.

Enamel surfaces & parts

- Clean with warm, soapy water and a clean cloth.
- Dry with a soft clean towel or cloth.
- Do not use steam cleaners.

Glass parts

- Only use a clean cloth wrung out in hot soapy water, or a specialist glass cleaner.
- Rinse away any excess cleaner and dry with a soft cloth.
- Do not use abrasives or polishes as they will scratch and damage the glass.
- The inner door glass panel can be removed for cleaning but it must be replaced the right way up. If there is any writing on the glass, you must be able to read it clearly when the cavity doors are open.
- Always make sure that the glass is pushed fully into the **Stop** position.
- To remove the glass panel, open the door wide, hold the top and bottom edges and slide out.
- Warning: Do not operate the appliance without the glass panel correctly fitted.



Always allow your appliance to cool down, and switch off the electricity before you clean any part of it.



Take extra care when cleaning over symbols on fascia panels, excessive cleaning can lead to the symbols fading.



Baby oil can be used to restore stainless steel finishes - but only use a few drops. Don't use cooking oils as they can contain salts which will damage the metal.



Don't use: undiluted bleaches, products containing chlorides or abrasive cleaners on aluminium or stainless steel, they can damage the appliance.

Glass door panels

For your safety, glass door panels are made of toughened glass. This ensures that, in the unlikely event that a panel breaks, it does so into small fragments to minimise the risk of injury.

Please take care when handling, using or cleaning all glass panels, as any damage to the surfaces or edges may result in the glass breaking without warning or apparent cause at a later date.

Should any glass panel be damaged, we strongly recommend that it is replaced immediately.

Before you call. .

Problem?	Advice
The ignition won't work. (Gas and dual fuel models)	<ul style="list-style-type: none">● Check there is a spark when the ignition button is depressed. If there is no spark, check the electricity supply is switched on at the socket.● Check that the gas supply is switched on.● Try another appliance in the socket, if that works replace the 3 amp fuse in the cooker plug.
There's condensation on the doors.	<p>Condensation is caused by hot, moist air meeting a cooler surface (i.e. the oven door). You cannot always prevent it, but you can minimise it when it happens by doing the following:</p> <ul style="list-style-type: none">● Pre-heat the oven at a high temperature before putting food in the oven, and cover the food you are cooking wherever possible.● Whenever you can, cook wet foods at higher temperatures.● Don't leave food in the oven to cool down. <p>Automatic cooking will normally produce condensation when the oven is cooling down with food inside.</p>
There's been a power failure and the oven won't work. (models with clocks and automatic programmers)	<ul style="list-style-type: none">● Switch off the electricity supply.● When the power returns - re-set the programmer/Clock to the correct time of day. <p>This will allow you to use your appliance.</p>

Changing Light Bulbs

Warning: There is a risk of electric shock, so always make sure you have turned off and unplugged your appliance.

Not all appliances have the same number and type of bulbs. Before replacing your bulb, open the top/main oven door and see which type you have. Then use the table to help you change your bulb correctly.

Please remember that bulbs are not covered by your warranty.

Bulbs can be purchased from hardware stores (always take the old bulb with you).

No. of lamps	Bulb Location	Oven type	Instruction for changing the bulb
2 (@25W)	side	All	Wait until the oven is cool, then remove the oven shelves. Grasp the lens cover on the light fitting and pull it away from the side of the oven. Unscrew the bulb.
1 (@25W)	rear	Fanned / Multifunction	Wait until the oven is cool, then remove the shelves. The oven light is at the rear of the oven cavity. Remove the loose oven back - unscrew the 4 securing screws (one at each corner). Unscrew the lens cover (turn anticlockwise). Unscrew the bulb and replace. Replace lens cover and replace oven back.
1 (@25W)	rear	Conventional	Wait until the oven is cool, then remove the oven shelves. The oven light is at the rear of the oven cavity. Unscrew the lens cover (turn anticlockwise). Unscrew the bulb and replace. Replace lens cover.

Installing Your Cooker

The information below is crucial to installing this appliance correctly and safely.

Regulations & Standards

always refer to the most recent issue of the standards

- Local / National Building Regulations
- AS/NZS 3000:2000.
- Local / National Electricity Regulations.
- Installation and Servicing Instructions for this appliance.

For installation the appliance must be connected in accordance with all local electrical regulations.

Failure to install appliances correctly is dangerous and could lead to prosecution.

Installing Your Cooker

Always make sure that your appliance is fitted correctly, by a competent electrician. This is a class 1 appliance regarding installation requirements, and must be earthed.

Before you start

- Always make sure that you have carefully read through the installation pages of this book - careful planning at the beginning will ensure a quick and easy installation.
- Take care when moving this appliance, it may be heavier than it looks! If you need to lift the appliance, make sure you use an appropriate lifting method.
- Soft, or uneven flooring may be damaged unless the appliance is moved with care.
- Do not attempt to move the cooker by pulling on the handles or doors, we recommend that you open the door and grasp the frame of the cooker. Please wear protective gloves for this, and make sure the door cannot trap your fingers.

Please make sure that you have enough space for your appliance. Clearances and more installation details are given on the following page.

Installing Your Cooker

Clearances

This cooker may be fitted flush to the base units of your kitchen.

- No shelf, overhang, cupboard, or cooker hood should be less than 650mm above the hob top, but please check this with the hood manufacturers instructions.
- If your appliance has a side opening door, we recommend a side clearance of 60mm to allow the oven door to fully open.
- The cooker must have a side clearance above hob level of 90mm up to a height of 400mm.
- The important dimensions are those around the appliance.

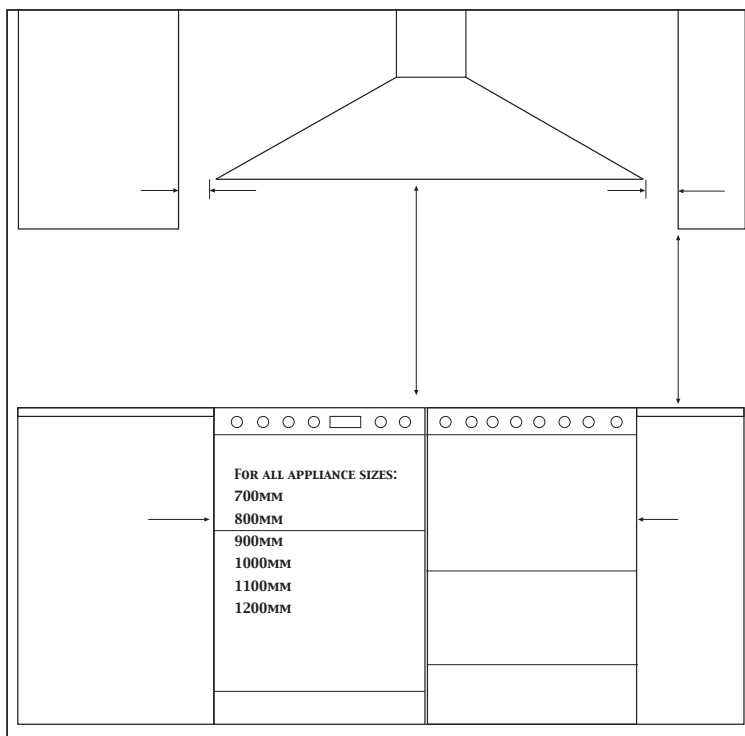

Installing Your Cooker

Fitting the plinth (if applicable)

- Make sure the appliance is raised to a height of 915mm or above before beginning. If the appliance is below 915mm - you can only fit the plinth cover labelled Y. You can adjust the height using the feet (1) of the appliance.

If your appliance has a storage drawer at the bottom, you access the required holes through the base of the drawer after lifting the mat.

- Open the appliance doors, and loosen screw A located on bracket (2). Do not remove this screw entirely.
- Insert screw B, through slot (3) and screw into the small hole at the bottom of bracket (2). Make sure that the plinth cover is flush to the appliance, but not over tightened.

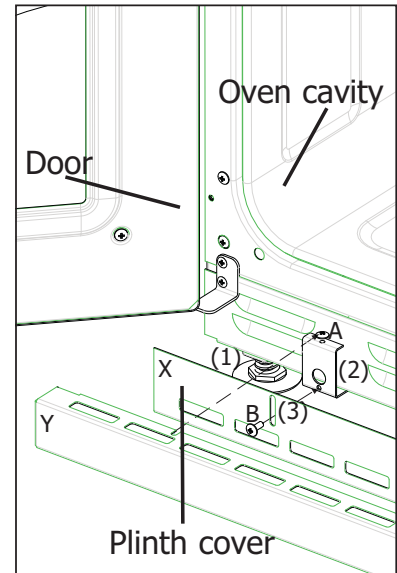

Fitting the splashback (if applicable)

- Loosely fit screw A and nut B into hole 1 at both ends of the rear surface of the appliance.
- Locate fitted screw A through the slots in both of the metal splashback plates.
- Tighten screw A and nut B.
- Now locate and tighten screw C and nut D through hole (2) at both ends of the rear surface of the appliance. Make sure that the splashback is securely attached, but avoid over tightening.

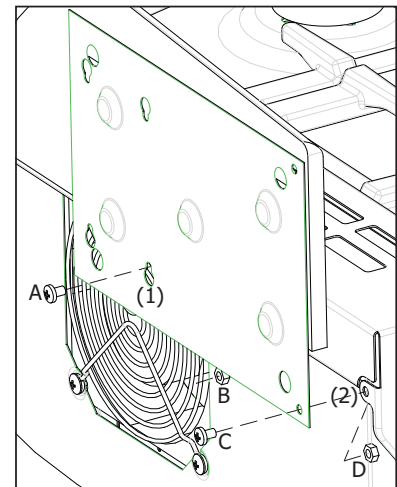

Fitting the towel rail (if applicable)

- On the towel rail there are two hole, top (A) and bottom (B), these holes have corresponding holes on the fascia at each end.
- The screw for the top hole (A), must be screwed into the supplied adaptor, whereas the remaining screw just goes through the bottom hole (B). Both screws are M6 screws. Using the allen key provided, tighten the screws making sure that the towel rail is flush to the fascia,

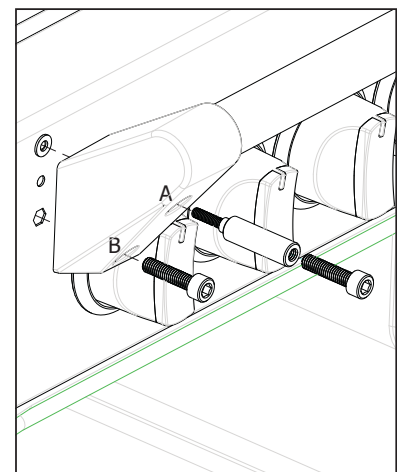

Installing Your Cooker

Connecting the electricity supply

- This appliance must be fitted using a double pole unit of 45 ampere minimum capacity with 3mm minimum contact at all poles.
- Access to the mains terminal is gained by opening the terminal block cover at the rear of the appliance - use a flat bladed screw driver for this.
- Connection should be made with a 6.0mm² twin and earth cable.
- Connection between the consumer unit (45AMCB/Fuse) and the cooker control unit should be made with 10mm² cable.
- First strip the wires. then push the cable through the cable clamping the terminal block cover.
- Connect the cable to the terminal block and tighten the cable clamp screw - see diagram.
- Close the terminal box, ensuring that the cover is engaged on the locking tabs.
- Sufficient cable should be used to allow the cooker to be pulled out, but must hang clear of the floor so it does not become twisted or trapped when the cooker is pushed back.

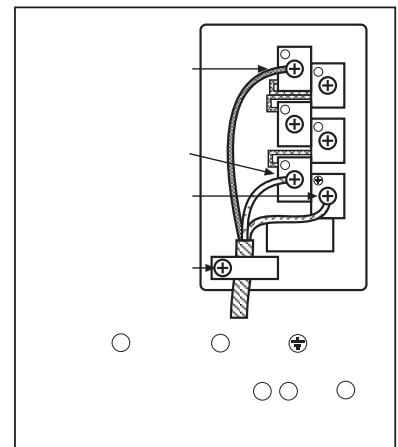

Please ensure that the user has this copy of the handbook, and the appliance is in place. Thank you.

Equipment you will need:
Flat bladed screw driver

Technical Data - Notes

Fuel Type	Hotplate Burner / Element	kW Rating
Ceramic - electric	Hob - Small Hob - Large Hob - Warming zone	1.1kW 1.7kW 0.1kW
Induction	Hob - large Hob - large (with boost) Hob - small Hob - small (when boost is in use)	1.8kW 3.0kW 1.2kW 0.6kW

Fuel Type	Multifunction oven	Fanned oven	Dual Variable grill (90 size)	Dual Variable grill (110 size)
Electric @ 230V	2.3kW	2.3kW	2.5kW	2.6kW
Slow cook oven (if fitted)	Conventional top oven (if fitted)	Oven lamps		
0.16kW	1.3kW	25W each		
Appliance size	110cm	90cm		
Maximum load	15.34kW			

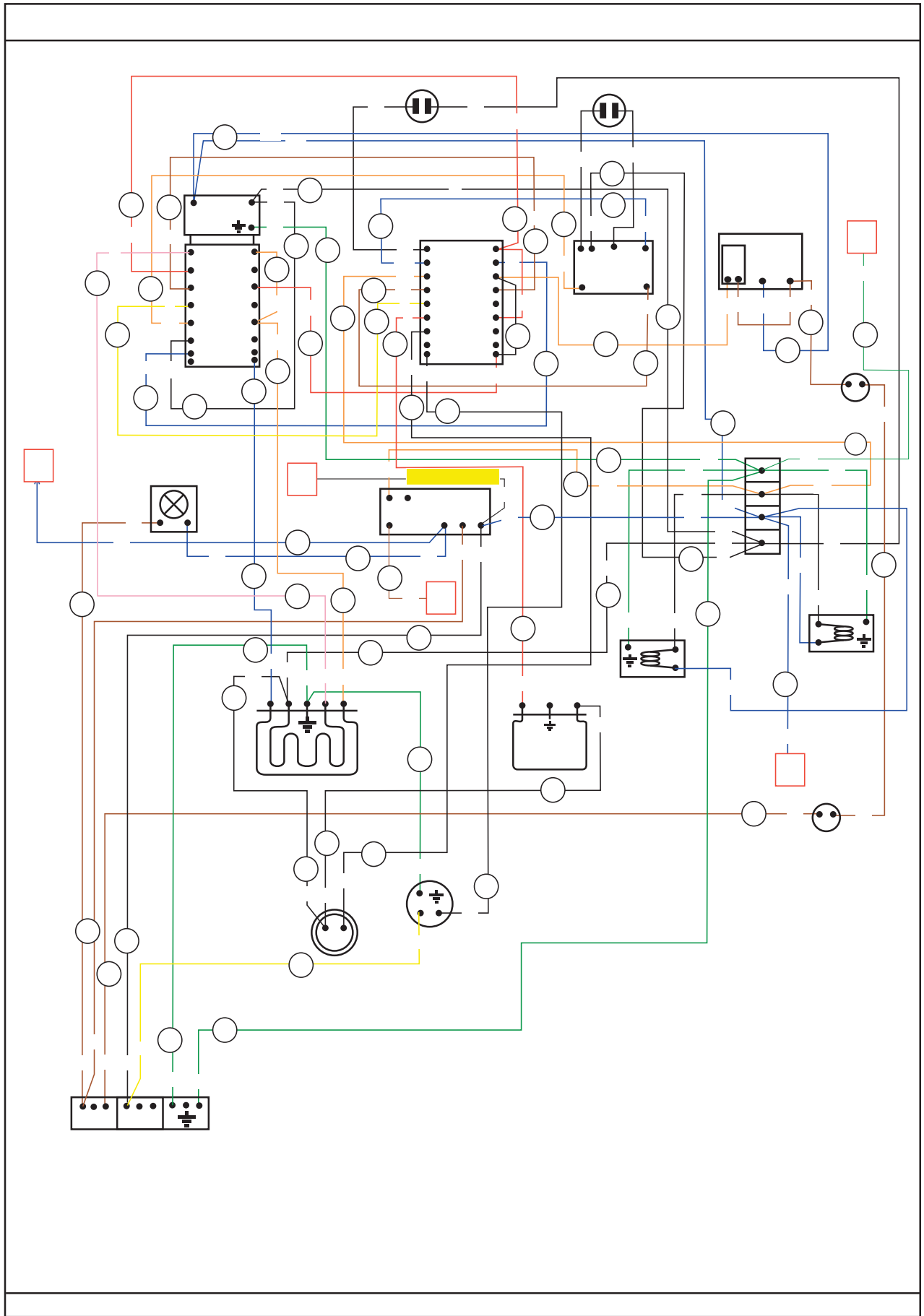

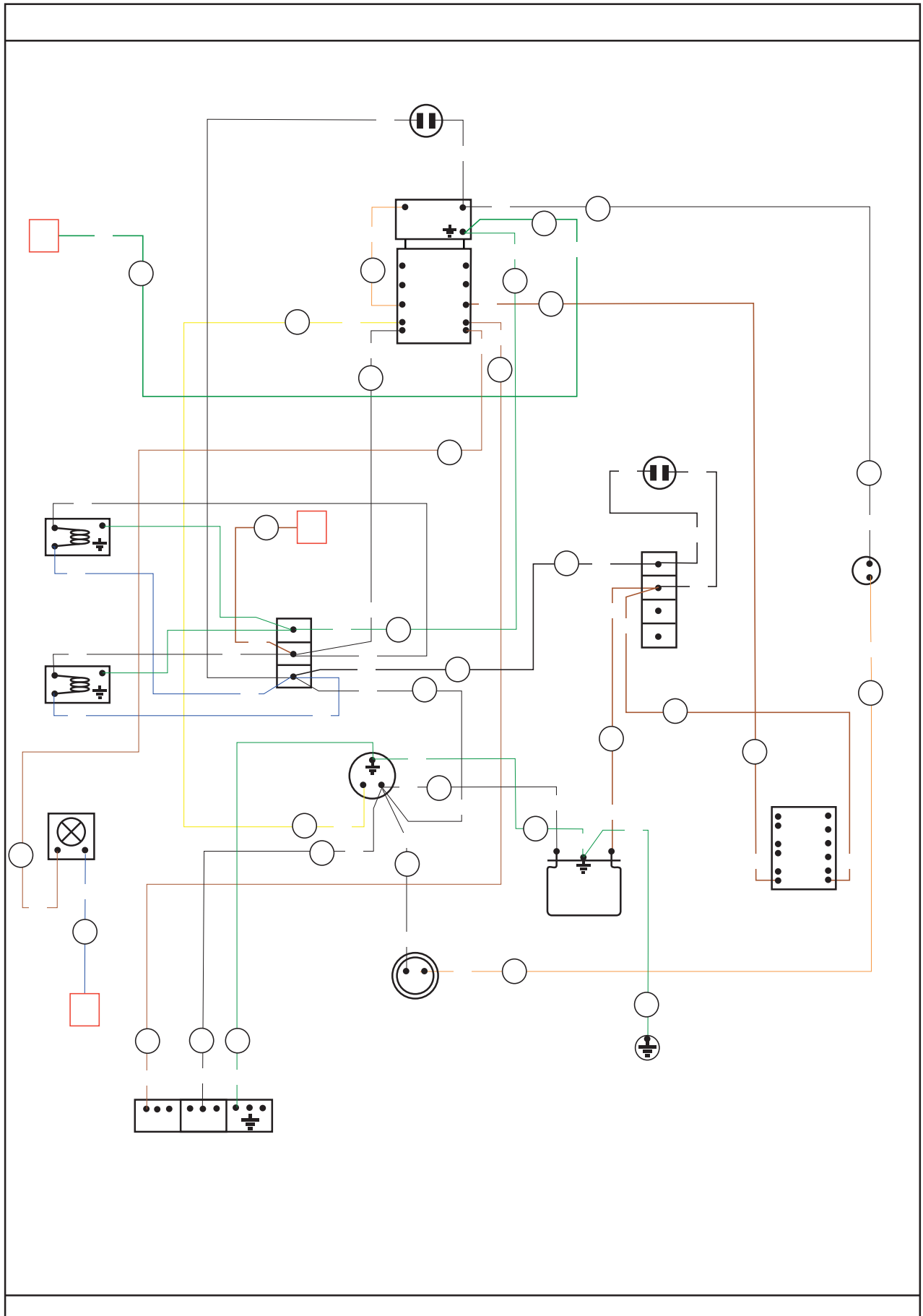

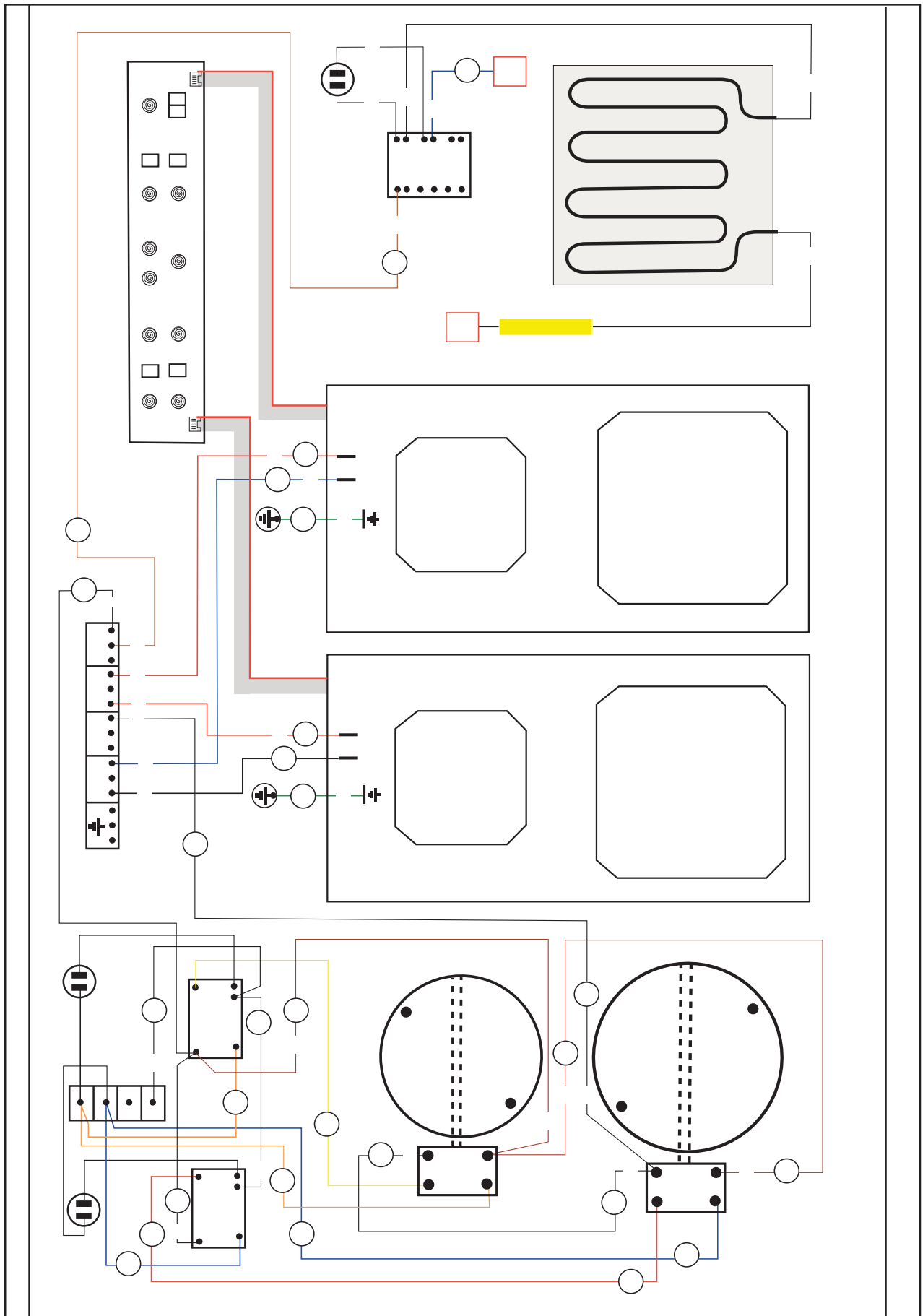

Service Record

Please record your model number and serial number in the space below.

Where are my model and serial numbers?

Freestanding HL appliances: base of storage drawer
 Freestanding appliances: front frame near oven cavity
 Built in oven: front frame near oven cavity
 Hobs: base plate of the hob

Having these numbers to hand will help us to help you, quickly and more efficiently. When contacting us, please use the Customer Care number on the back cover of this handbook.

Model Number									
Serial Number									

Date of purchase	Installer stamp / Printed name	Date of installation
Place of purchase:		

Date	Part(s) replaced	Engineers Stamp/ Printed Name

Contact Us

Calling for a service

If you should experience any problems with your cooker please contact your retailer or place of purchase.

Important note:

Service work is to be conducted by authorised persons only. It is also advisable that your cooker is checked regularly and maintained in good condition. An annual maintenance is recommended.

Always check the instruction book before calling a service agent to make sure you have not missed anything.

Glen Dimplex Australia Pty Ltd Customer Care:

Tel: 1-300-556-816

Before you contact a service agent, make sure that you have the following information to hand:

Model Number

Serial Number

Date of Purchase

Postcode



GLEN DIMPLEX
AUSTRALIA PTY LTD

Glen Dimplex Australia, Unit 2, 205 Abbots Road, Dandenong South, Victoria 3175
Australia

e-mail: sales@glendimplex.com.au

web: www.glendimplex.com.au

08 27318 03 © 03.2008

Electric Range

Model Names: Sterling 1100E